

LC7985NA, LC7985ND

LCD Controller/Driver

Overview

The LC7985 series devices are low-power CMOS ICs that incorporate dot-matrix character generator, display controller and driver functions in a single device, making them ideal for use in portable equipment containing LCD displays.

The LC7985 series feature 5×7 -pixel and 5×10 -pixel character fonts including either eight or four user-defined characters, single-line and two-line display modes, built-in drivers for displays up to eight characters in size, and easy expansion to control displays of up to 80 characters by adding LC7930N display drivers.

The LC7985 series interface directly to both 4-bit and 8-bit microcontrollers. The instruction set includes display clear, cursor home, display ON/OFF, character blink, and cursor and display shift instructions. The built-in reset circuit automatically initializes the devices at power-ON.

The LC7985 series operate from a 5V supply and are available in 80-pin QIPs.

Features

- Controller and driver for dot-matrix LCD displays
- 5×7 -pixel and 5×10 -pixel character fonts
- 160, 5×7 -pixel characters and 32, 5×10 -pixel characters in character generator ROM
- Eight, 5×7 -pixel characters or four, 5×10 -pixel characters in character generator RAM
- 80-character display data RAM
- Built-in drivers for 1-line \times 8-character and 2-line \times 8-character displays
- Easy expansion to 1-line \times 80-character or 2-line \times 40-character displays
- 4-bit or 8-bit microcontroller interface
- 11 microcontroller instructions
- Built-in reset circuit
- Built-in oscillator
- 5V supply
- 80-pin QIP

Package Dimensions

unit: mm

3044B - QFP80A

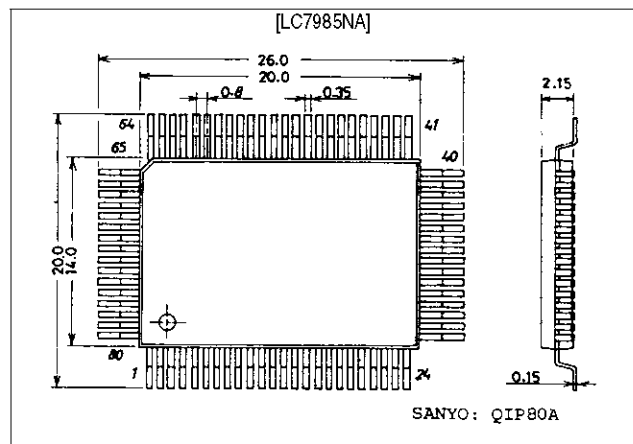

unit: mm

3177 - QFP80D

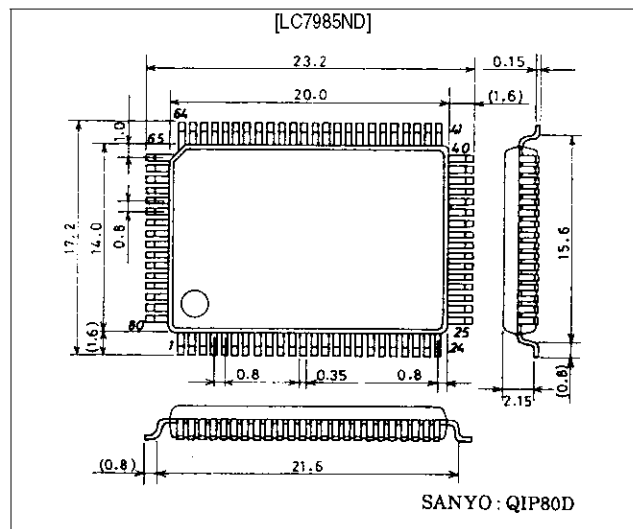

Pin Assignment

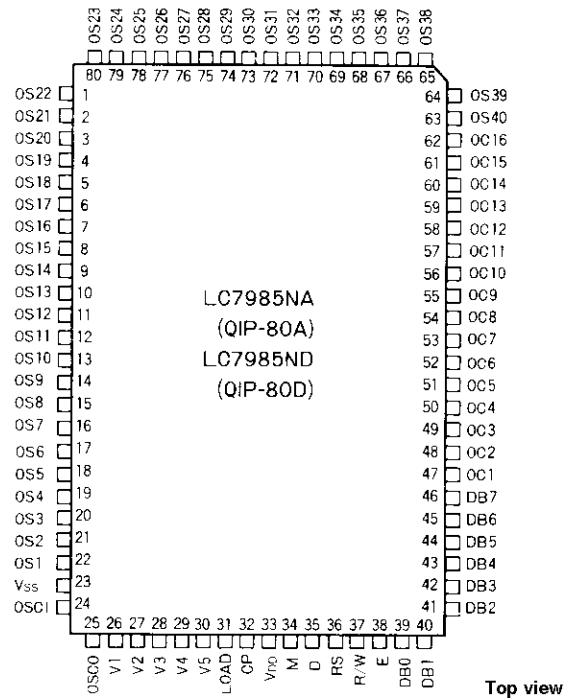

Block Diagram

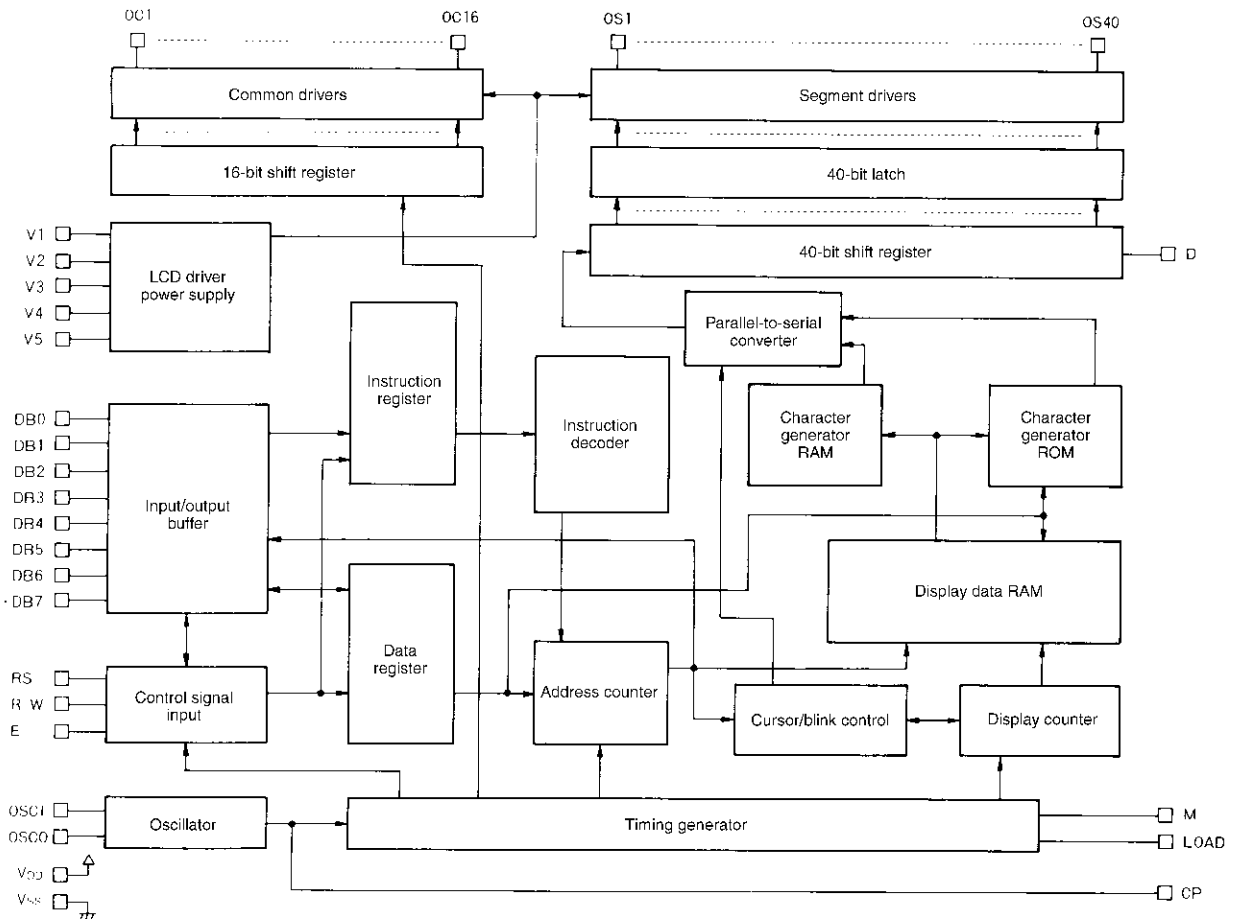

Specifications

Absolute Maximum Ratings at $T_a = 25 \pm 2^\circ\text{C}$, $V_{SS} = 0\text{V}$

Parameter	Symbol	Ratings	Unit
Supply voltage range	V_{DD}	-0.3 to +7.0	V
LCD drive supply voltage range* ¹	V_1 to V_5	$V_{DD} - 13.5$ to $V_{DD} + 0.3$	V
Input voltage range	V_I	-0.3 to $V_{DD} + 0.3$	V
Operating temperature range	T_{opr}	-20 to +75	°C
Storage temperature range	T_{stg}	-55 to +125	°C

Note: *1. V_{DD} must obey the relationship : $V_{DD} \geq V_1 \geq V_2 \geq V_3 \geq V_4 \geq V_5$

Allowable Operating Ranges at $T_a = -20$ to $+75^\circ\text{C}$

Parameter	Symbol	Conditions	Ratings			Unit
			min	typ	max	
Supply voltage range	V_{DD}		4.5		5.5	V
Supply voltage* ¹	V_{D5}	$V_{D5} = V_{DD} - V_5$	1.5			V
	V_{D1}	$V_{D1} = V_{DD} - V_1$			$V_{D5} \times 0.25$	V
Input high level voltage	V_{IH1}	except OSCI	2.2		V_{DD}	V
	V_{IH2}	OSCI only	$V_{DD} - 1.0$		V_{DD}	V
Input low level voltage	V_{IL1}	except OSCI			0.6	V
	V_{IL2}	OSCI only			1.0	V

Note: *1. These voltages guarantee correct operation of the LC7985NA and LC7985ND. They do not guarantee correct operation of the LCD panel.
 V_{LCD} must also be observed.

Electrical Characteristics at $T_a = -20$ to $+75^\circ\text{C}$, $V_{SS} = 0\text{V}$, $V_{DD} = 5\text{V} \pm 10\%$, unless otherwise noted

Parameter	Symbol	Conditions	Ratings			Unit
			min	typ	max	
Output high-level voltage	V_{OH1}	$I_{OH} = -0.205\text{mA}$ Input / Output pins	2.4	-	-	V
	V_{OH2}	$I_{OH} = -0.04\text{mA}$ Output pins	$0.9V_{DD}$	-	-	V
Output low-level voltage	V_{OL1}	$I_{OL} = 1.2\text{mA}$ Input / Output pins	-	-	0.4	V
	V_{OL2}	$I_{OL} = 0.04\text{mA}$ Output pins	-	-	$0.1V_{DD}$	V
Driver fall voltage* ¹	V_{COM}	$I_d = 0.05\text{mA}$ All common pins	-	-	2.9	V
	V_{SEG}	$I_d = 0.05\text{mA}$ All segment pins	-	-	3.8	V
Leakage current	I_L	$V_I = V_{SS}$ to V_{DD}	-	-	1	μA
Pull-up current* ²	I_P	$V_{DD} = 5\text{V}$	50	125	250	μA
Current drain	I_{DD1}	Ceramic resonator oscillator, $V_{DD} = 5\text{V}$, $f_{OSC} = 250\text{kHz}$, no output load	-	0.55	0.8	mA
	I_{DD2}	Feedback resistor oscillator, $V_{DD} = 5\text{V}$, $f_{OSC} = 270\text{kHz}$, no output load	-	0.35	0.6	
External clock* ³	Frequency	f_{CP}	125	250	350	kHz
	Duty cycle	DUTY	45	50	55	%
Rise time	t_R		-	-	0.2	μs
Fall time	t_F		-	-	0.2	μs

LC7985NA, LC7985ND

Parameter	Symbol	Conditions	Ratings			Unit
			min	typ	max	
Internal oscillator frequency	f_{OSC1}	Ceramic filter oscillator	245	250	255	kHz
	f_{OSC2}	Feedback resistor oscillator, $R_f = 91k\Omega \pm 3\%$	190	270	350	
LCD display voltage	V_{LCD1}	1/5 bias, $V_{LCD} = V_{DD} - V_5$	4.6	–	11	V
	V_{LCD2}	1/4 bias, $V_{LCD} = V_{DD} - V_5$	3.0	–	11	

Note: *1. V_{COM} is the voltage from VDD, V1, V4 and V5 to the LCD common drive pins OC1 to OC16.

V_{SEG} is the voltage from VDD, V2, V3 and V5 to the LCD segment drive pins OC1 to OC40.

Note: *2. Applied pins are RS, R/W, and DB0 to DB7.

Note: *3. External clock

Switching Characteristics at $T_a = -20$ to $+75^\circ\text{C}$, $V_{DD} = 5V \pm 10\%$, $V_{SS} = 0V$

Parameter	Symbol	Conditions	Ratings			Unit
			min	typ	max	
E cycle time	t_{ECCY}		1000	–	–	ns
E high-level pulsewidth	t_{EW}		450	–	–	ns
E rise time	t_{ER}		–	–	25	ns
E fall time	t_{EF}		–	–	25	ns
RS and R/W to E setup time	t_{SU}		140	–	–	ns
E to RS and R/W address hold time	t_{AH}		10	–	–	ns
DB0 to DB7 to E data setup time	t_{DSU}		195	–	–	ns
Write cycle E to DB0 to DB7 data hold time	t_{DHW}		10	–	–	ns
Read cycle E to data valid delay time	t_{DD}	See measurement circuit.	–	–	320	ns
Read cycle E to DB0 to DB7 data hold time	t_{DHR}		20	–	–	ns
CP low-level pulsewidth	t_{WL}		800	–	–	ns
CP high-level pulsewidth	t_{WH}		800	–	–	ns
CP to LOAD setup time	t_{CSU}		500	–	–	ns
D to CP data setup time	t_{DSU}		300	–	–	ns
CP to D data hold time	t_{DH}		300	–	–	ns
LOAD to M delay time	t_{DM}		–1000	–	1000	ns

Reset characteristics at $T_a = -20$ to $+75^\circ\text{C}$

Parameter	Symbol	Conditions	Ratings			Unit
			min	typ	max	
V_{DD} rise time	t_{DDR}		0.1	–	10	μs
V_{DD} off time	t_{DDOFF}		1	–	–	ms

Clock Generator

The internal oscillator that generates the clock for the internal circuit requires an external filter, a feedback resistor or an external clock input as shown in the following sections.

External clock

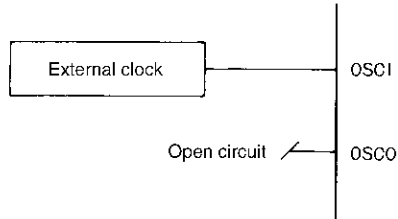

The input duty cycle should be between 45 and 55% as shown in the following figure.

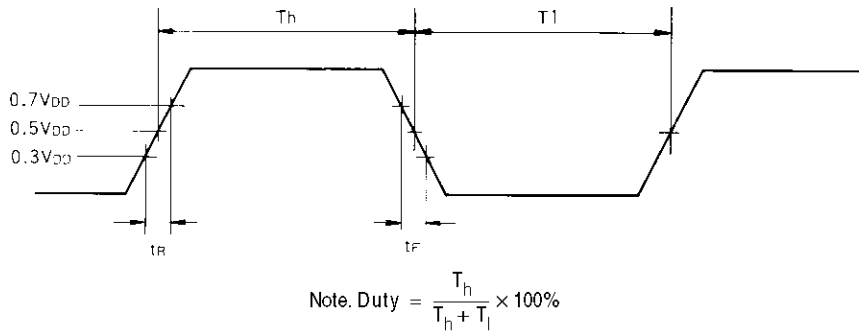

Ceramic filter

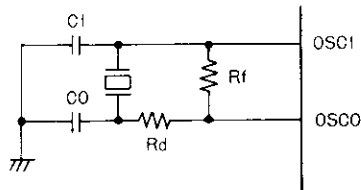

Note. $R_f = 1M\Omega \pm 10\%$, $C_1 = C_0 = 680pF \pm 10\%$, $R_d = 3.3k\Omega \pm 5\%$

Feedback resistor

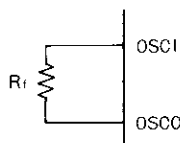

Note. The resistor should be mounted as close as possible to OSC1 and OSC0.

Measurement Circuit

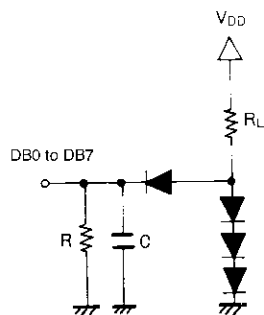

Note. $R_L = 2.4k\Omega$, $C = 130pF$, $R = 11k\Omega$

Read/write cycle timing

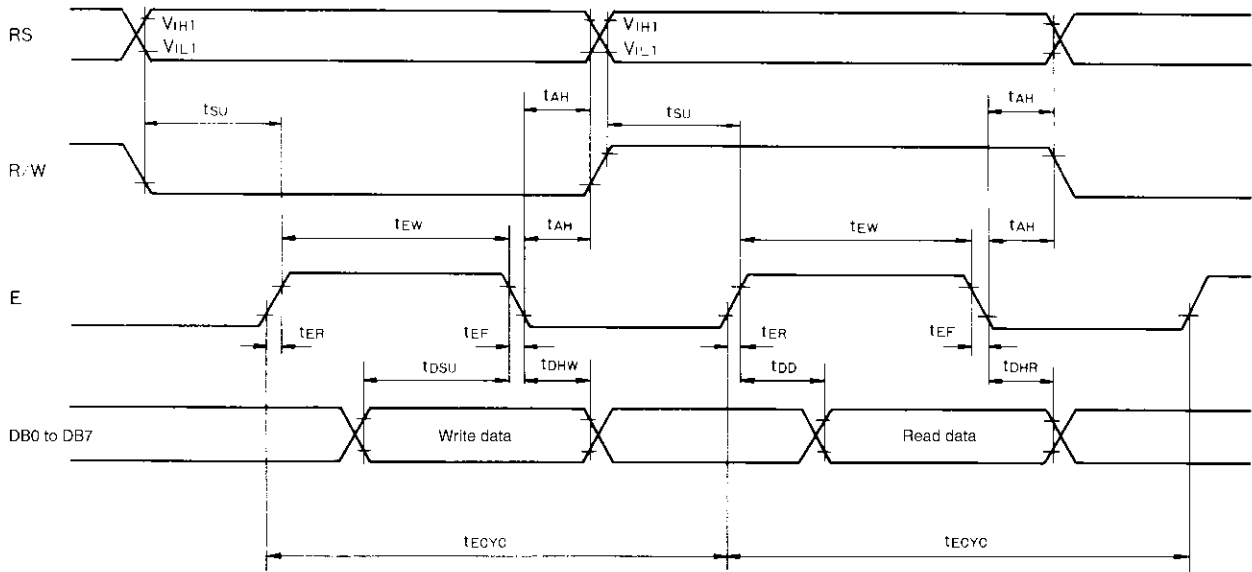

LC7930N interface timing

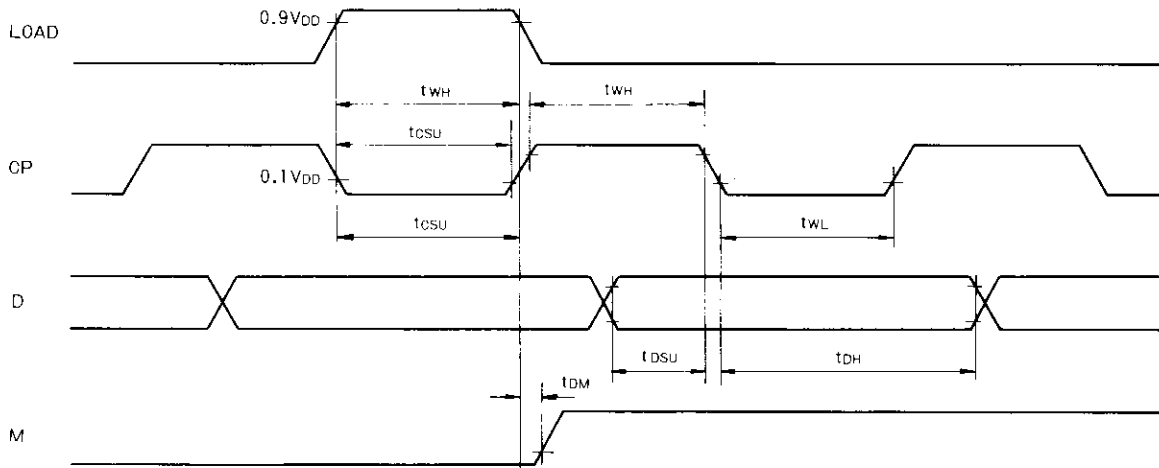

Power supply

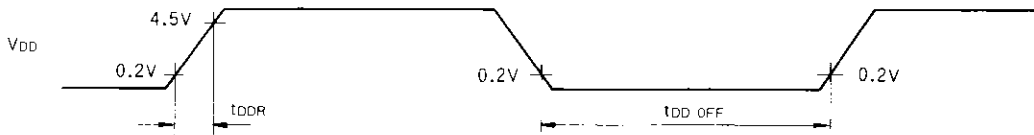

Pin Description

Name	Num	I/O	Connect to	Functions
RS	1	I	MPU	Data register or instruction register select input. Data register when "1" and instruction register when "0".
R/W	1	I	MPU	Read or write select input "0" indicates write, "1" ; read
E	1	I	MPU	Execution start input to write or read
DB ₄ to DB ₇	4	I/O	MPU	4-bit microcontroller interface data bus and 8-bit microcontroller interface high-order four bits data bus connections. Three-state bidirectional. DB ₇ can be used as a busyflag.
DB ₀ to DB ₃	4	I/O	MPU	8-bit microcontroller interface low-order four bits data bus connections. No connection when 4-bit interface size is selected. Three-state bidirectional.
LOAD	1	O	LC7930N	Clock to latch the D serial data output to LC 7930N
CP	1	O	LC7930N	Clock to shift the D serial data
M	1	O	LC7930N	Output to shift the LCD drive signal to alternating current signal
D	1	O	LC7930N	Display expansion serial data output "0" indicates unselected, "1" ; selected
OC ₁ to OC ₁₆	16	O	LCD	LCD common driver outputs. All common signals unused are unselected wave forms.
OS ₁ to OS ₄₀	40	O	LCD	LCD segment driver outputs
V ₁ to V ₅	5		source	Supply voltage for LCD display drive
V _{DD} , V _{SS}	2		source	V _{DD} : +5V, V _{SS} : 0V
OSCI, OSCO	2			Oscillator feedback resistor and ceramic filter connection, and external clock input

Functional Description

Registers

The LC7985 has two 8-bit registers—instruction register (IR) and data register (DR)—that are selected as shown in the following table.

RS	RAW	Operation
0	0	IR write, instruction execution
0	1	Busy flag (DB7) and address counter (DB0 to DB6) output
1	0	DR write, internal DR to DD RAM or CG RAM data transfer
1	1	DR read, internal DD RAM or CG RAM to DR data transfer

The instruction register is write-only. It contains instruction codes or DD RAM and CG RAM addresses written by the microcontroller.

Busy Flag

When busy flag is 1, the previous instruction is executing, and when 0, the instruction has completed. The next instruction cannot be received until BF is 0. The microcontroller should, therefore, confirm that BF is 0 before writing the next instruction.

Display Data RAM (DD RAM)

The display data RAM stores 80, 8-bit character codes, and the LC7985 can display a maximum of 80 characters. The address counter contains the location for the next display memory read or write operation as shown in the following figure.

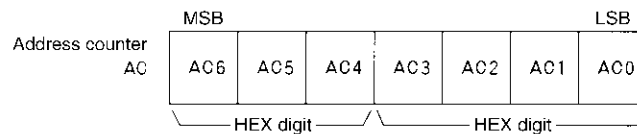

Display data addresses are in hexadecimal. For example, the address counter contents for location 4E are shown in the following figure.



To prevent undesirable effects such as display flicker during DD RAM accesses, the internal memory and the microprocessor interface have separate timing signals.

The data register holds data read from or written to either DD RAM or CG RAM. Data written to the data register by the microcontroller is automatically transferred to the current DD RAM or CG RAM address. Data read from DD RAM or CG RAM is buffered in the data register.

When the microcontroller writes a DD RAM or CG RAM address to the instruction register, the data at that address is copied into the data register. The microcontroller then reads the data in the data register to complete the transfer. Once that data is read, the data from the next DD RAM or CG RAM address is copied into the data register in preparation for the next data read.

Address Counter

The address counter is used for both the DD RAM and the CG RAM. The address output on DB0 to DB7 is the counter value before the currently executing instruction began.

Single-line display mode (N = 0)

The DD RAM addresses and their corresponding display positions for an 80-character display are shown in the following figure.

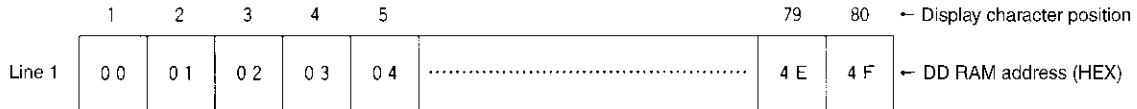

A single LC7985, however, can drive up to eight characters. The display positions and DD RAM addresses for an unshifted 8-character display are shown in the following figure.

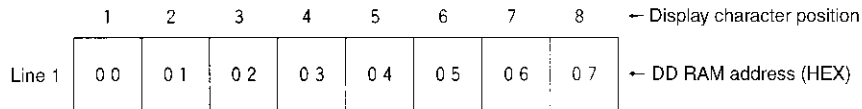

The DD RAM addresses following left and right display shifts are shown in the following figure. Note that the displayed characters wrap around from addresses 4FH to 00H.

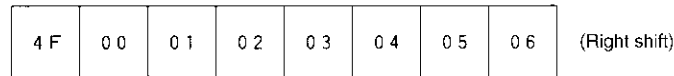
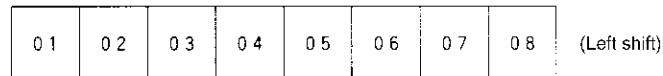

An LC7985 and a single LC7930N can drive a 16-character display. The display positions and DD RAM addresses for an unshifted display are shown in the following figure.

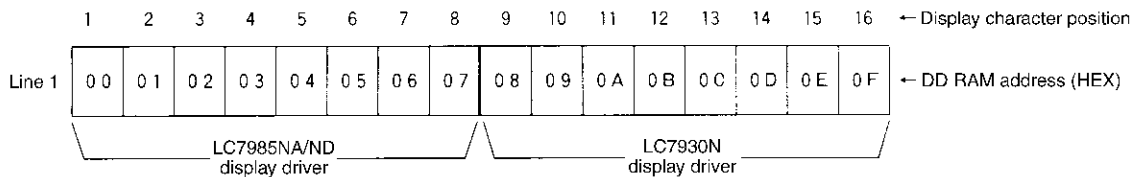

The DD RAM addresses following left and right display shifts are shown in the following figure.

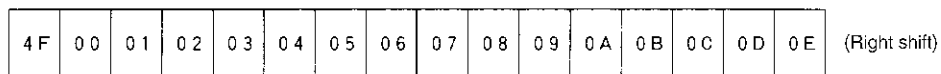
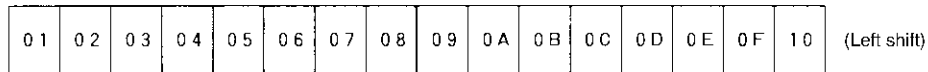

The number of displayed characters can be increased by adding more LC7930Ns. An LC7985 and nine LC7930Ns can drive an 80-character display as shown in the following figure.

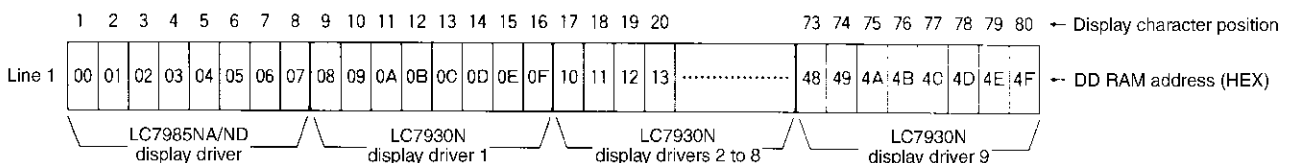

LC7985NA, LC7985ND

Two-line display mode (N = 1)

The DD RAM addresses and their corresponding display positions for a 2-line × 40-character display are shown in the following figure. Note that the address counter automatically increments from 27_H to 40_H.

	1	2	3	4	5															39	40	← Display character position
Line 1	00	01	02	03	04														26	27	← DD RAM address (HEX)
Line 2	40	41	42	43	44														66	67	

A single LC7985, however, can drive up to eight characters per line. The display positions and DD RAM addresses for an unshifted, 2-line × 8-character display are shown in the following figure.

	1	2	3	4	5	6	7	8	← Display character position
Line 1	00	01	02	03	04	05	06	07	← DD RAM address (HEX)
Line 2	40	41	42	43	44	45	46	47	

The display positions following a left or right display shift are shown in the following figure. Note that the display shift is simultaneous for both lines, regardless of which line the cursor is in.

01	02	03	04	05	06	07	08	(Left shift)
41	42	43	44	45	46	47	48	
								(Right shift)
27	00	01	02	03	04	05	06	
67	40	41	42	43	44	45	46	

An LC7985 and a single LC7930N can drive a 2-line × 16-character display. The display positions and DD RAM addresses for an unshifted, 2-line × 16-character display are shown in the following figure.

	1	2	3	4	5	6	7	8	9	10	11	12	13	14	15	16	← Display character position
Line 1	00	01	02	03	04	05	06	07	08	09	0A	0B	0C	0D	0E	0F	← DD RAM address (HEX)
Line 2	40	41	42	43	44	45	46	47	48	49	4A	4B	4C	4D	4E	4F	
								<div style="display: flex; justify-content: space-around; width: 100%;"> LC7985NA/ND display driver LC7930N display driver </div>									

The DD RAM addresses following left and right display shifts are shown in the following figure.

01	02	03	04	05	06	07	08	09	0A	0B	0C	0D	0E	0F	10	(Left shift)
41	42	43	44	45	46	47	48	49	4A	4B	4C	4D	4E	4F	50	
																(Right shift)
27	00	01	02	03	04	05	06	07	08	09	0A	0B	0C	0D	0E	
67	40	41	42	43	44	45	46	47	48	49	4A	4B	4C	4D	4E	

LC7985NA, LC7985ND

The number of displayed characters can be increased by adding more LC7930Ns. An LC7985 and four LC7930Ns can drive a 2-line × 40-character display as shown in the following figure.

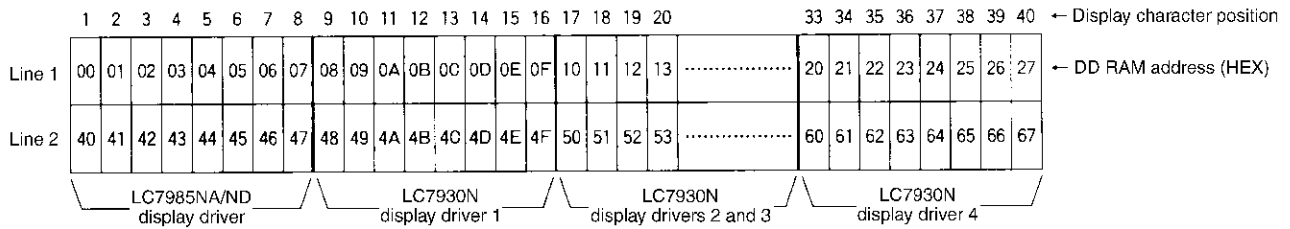

Character Generator ROM (CG ROM)

The character generator ROM contains 160, 5 × 7-pixel bitmaps and 32, 5 × 10-pixel bitmaps as shown in the following figure. The characters are selected by their 8-bit character code.

Character Generator RAM (CG RAM)

The character generator RAM stores user-defined bitmaps for either eight, 5 × 7-pixel characters or four, 5 × 10-pixel characters. To display character patterns stored in CG RAM, write the character codes, shown in the leftmost column of the following figure, on DD RAM.

Character cord and the character bitmap

Upper Lower 4bit 4bit	0000	0010	0011	0100	0101	0110	0111	1010	1011	1100	1101	1110	1111
xxxx0000	CG RAM (1)		Q	R	P	q	r		—	Q	R	q	r
xxxx0001	(2)	!	l	o	a	g	g	7	7	4	5	6	9
xxxx0010	(3)	"	z	e	r	r	r	t	t	w	x	p	e
xxxx0011	(4)	#	s	o	s	c	a	u	u	t	t	e	e
xxxx0100	(5)	\$	a	d	a	t	t	t	t	t	t	p	a
xxxx0101	(6)	%	s	e	u	e	u	e	u
xxxx0110	(7)	&	e	f	v	v	v	v	v	v	v	e	v
xxxx0111	(8)	'	z	a	w	a	w	7	7	7	7	g	a
xxxx1000	(1)	(e	a	x	x	x	x	x	x	x	x	x
xxxx1001	(2))	9	t	v	i	w	e	t	t	t	y	y
xxxx1010	(3)	*	#	j	z	z	z	z	z	z	z	j	#
xxxx1011	(4)	+	k	k	k	k	k	k	k	k	k	k	#
xxxx1100	(5)	,	<	f	i	i	i	i	i	i	i	f	,
xxxx1101	(6)	—	=	n	n	n	n	n	n	n	n	=	—
xxxx1110	(7)	.	>	n	n	n	n	n	n	n	n	n	.
xxxx1111	(8)	/	?	o	o	o	o	o	o	o	o	o	/

5 × 7-pixel characters

The layout and addressing for 5 × 7-pixel characters is shown in the following figure. Each character occupies eight bytes, where bits 3 to 5 of the CG RAM address correspond to bits 0 to 2 of the character code. Note that bit 3 of the character code is not significant so, for example, codes 00_H and 08_H select the same character.

Bits 0 to 2 of the CG RAM address are the bitmap row address, where row 000 is the topmost displayed row.

The cursor, when displayed, is formed by ORing the bottom row with all 1s. If the cursor is used, row 111 should contain all 0s so the cursor does not obscure the bottom row of the character.

Bits 0 to 4 of the CG RAM data contain the character bitmaps. When a bit is 1, the corresponding pixel is ON, and when 0, the pixel is OFF.

Bits 5 to 7 of the CG RAM data are present in memory, but are not used by the display circuit. These bits can be used as general-purpose RAM.

Character code (DD RAM data)								CG RAM address								Character bitmap (CG RAM data)												
7	6	5	4	3	2	1	0	5	4	3	2	1	0	7	6	5	4	3	2	1	0							
←MSB				LSB→				←MSB				LSB→				←MSB				LSB→								
0 0 0 0 * 0 0 0								0 0 0								0	0	0	*				1	1	1	1	0	Character bitmap 1
																0	0	1	*				1	0	0	0	1	
																0	1	0	*				1	0	0	0	1	
																0	1	1	*				1	1	1	1	0	
																1	0	0	*				1	0	1	0	0	
																1	0	1	*				1	0	0	1	0	
																1	1	0	*				1	0	0	0	1	
																1	1	1	*				* * *	0	0	0	0	
0 0 0 0 * 0 0 1								0 0 1								0	0	0	*				1	0	0	0	1	Character bitmap 2
																0	0	1	*				0	1	0	1	0	
																0	1	0	*				1	1	1	1	1	
																0	1	1	*				0	0	1	0	0	
																1	0	0	*				1	1	1	1	1	
																1	0	1	*				0	0	1	0	0	
																1	1	0	*				0	0	1	0	0	
																1	1	1	*				* * *	0	0	0	0	
0 0 0 0 * 1 1 1								1 1 1								0	0	0	*									
																1	0	0	*									
																1	0	1	*									
																1	1	0	*									
																1	1	1	*									

* Don't care

5 × 10-pixel characters

The layout and addressing for 5 × 10-pixel characters is shown in the following figure. Each character occupies eleven bytes, where bits 4 and 5 of the CG RAM address correspond to bits 1 and 2 of the character code. Note that bits 0 and 3 of the character code are not significant so, for example, codes 00_H, 01_H, 08_H and 09_H all select the same character.

Bits 0 to 3 of the CG RAM address are the bitmap row address where row 000 is the topmost displayed row.

The cursor, when displayed, is formed by ORing the bottom row with all 1s. If the cursor is used, row 1010 should

contain all 0s so the cursor does not obscure the bottom row of the character.

Bits 0 to 4 of the CG RAM data contain the character bitmaps. When a bit is 1, the corresponding pixel is ON, and when 0, the pixel is OFF.

Bits 5 to 7 of the CG RAM data are present in memory, but are not used by the display circuit. These bits and the CG RAM bytes, rows 1011 to 1111 that are not used by the display circuit, can be used as general-purpose RAM.

Character code (DD RAM data)								CG RAM address						Character bitmap (CG RAM data)									
7	6	5	4	3	2	1	0	5	4	3	2	1	0	7	6	5	4	3	2	1	0		
←MSB				LSB→				←MSB			LSB→			←MSB				LSB→					
										0	0	0	0	*	*	*	0	0	0	0	0		
										0	0	0	1		↓		0	0	0	0	0		
										0	0	1	0				1	0	1	1	0		
										0	0	1	1				1	1	0	0	1		
										0	1	0	0				1	0	0	0	1		
0	0	0	0	*	0	0	*	0	0	0	1	0	1				1	0	0	0	1		
										0	1	1	0				1	1	1	1	0		
										0	1	1	1				1	0	0	0	0		
										1	0	0	0				1	0	0	0	0		
										1	0	0	1				1	0	0	0	0		
										1	0	1	0	*	*	*	0	0	0	0	0		
										1	0	1	1				*	*	*	*	*		
										1	1	0	0				*	*	*	*	*		
										1	1	0	1				*	*	*	*	*		
										1	1	1	0				*	*	*	*	*		
										1	1	1	1	*	*	*	*	*	*	*	*		
										0	0	0	0				*	*	*				
										0	0	0	1				*	*	*				
										1	1	1	0	0	1				*	*	*		
										1	0	1	0				*	*	*				
										1	0	1	1				*	*	*	*	*		
										1	1	0	0				*	*	*	*	*		
										1	1	0	1				*	*	*	*	*		
										1	1	1	0				*	*	*	*	*		
										1	1	1	1	*	*	*	*	*	*	*	*		

* Don't care

Timing Generator

This circuit generates timing signals both for internal circuit operation and for driving external LC7930Ns. The timing signals for the DD RAM, CG ROM and CG RAM are independent of the microcontroller interface so that memory accesses by the microcontroller do not cause interference with the display drive signals.

Display Drivers

The LC7985 incorporates 16 LCD common driver outputs and 40 LCD segment driver outputs. The character font and the number of display lines determine the number of active common outputs.

The segment drivers function identically to the LC7930N display drivers. The character bitmap data to be displayed is latched in the internal 40-bit shift register before being output on the segment drivers.

The display bitmap data for each pixel-row is generated starting with the right-most character position. The data shifts through the shift register and is output on the shift register serial data output. The shift register latches the last 40 bits in the row so the LC7985 displays the left-most eight characters. External LC7930Ns connect in series to the serial data output and each one latches and displays bitmap data for eight additional characters.

Cursor Display and Blinking

Cursor display and blinking of the character at the cursor position are controlled using the Display ON/OFF instruction. The cursor position is at the character corresponding to the address counter value as shown in the following figure.

Note that the cursor and blinking character are also displayed at the address counter value when CG RAM is selected.

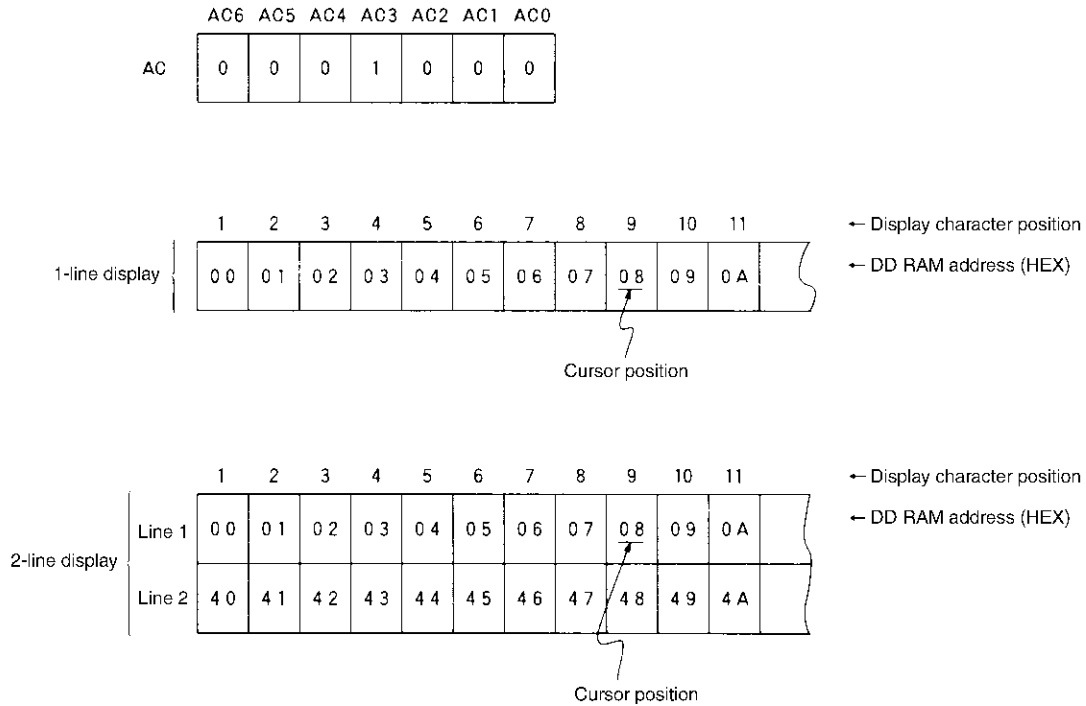

Microcontroller Interface

The LC7985 interfaces to both 4-bit and 8-bit microcontrollers.

DB0 to DB7 are used for the 4-bit data bus. Two read or write cycles, therefore, are required to transfer each data,

status or instruction byte. The high-order four bits—bits DB4 to DB7 in 8-bit interface mode—are transferred first. The low-order four bits are then transferred as shown in the following figure.

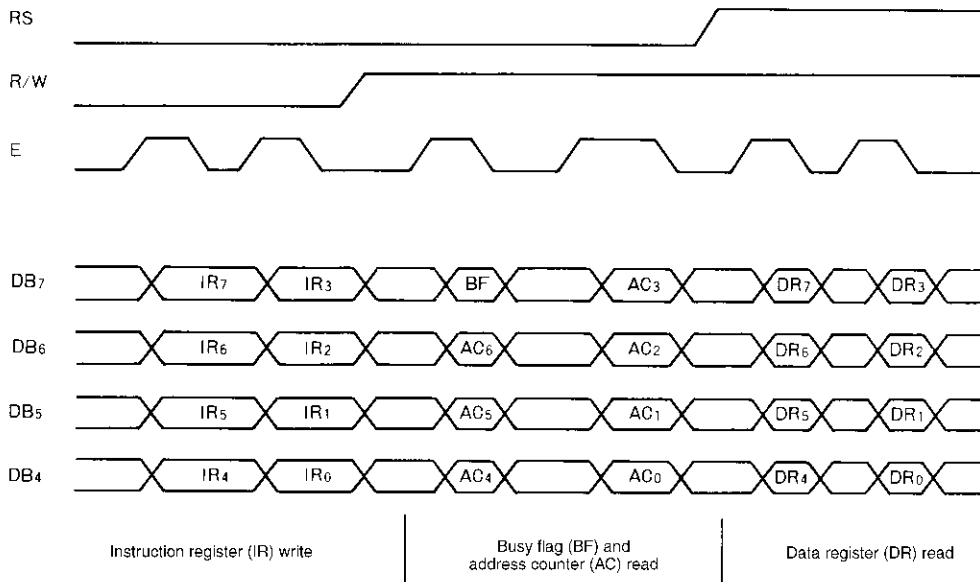

Reset Circuit

The internal reset circuit initializes the LC7985 at power-ON. The busy flag remains ON from power-ON until initialization is complete 10ms after V_{DD} reaches 4.5V. Note that if power supply conditions are such that the internal reset circuit does not operate to initialize the device, the LC7985 must be initialized using commands from the microcontroller.

The initialization sequence is as follows.

1. Clear Display
2. Set Function ($D/L = 1, N = 0, F = 0$)
Sets 8-bit interface size, 1-line display size and 5×7 -pixel character font.
3. Cursor/Display Control ($D = 0, C = 0, B = 0$)
Sets the display, the cursor and character blinking OFF.
4. Set Entry Mode ($I/D = 1, S = 0$)
Sets address counter auto-increment and sets display shift OFF.

Instructions

The external microcontroller accesses two register—instruction register and data register—to control the LC7985. So the microcontroller interface is independent of the microcontroller clock frequency, the LC7985 stores the instruction of data internally before executing it.

There are four types of instructions.

- Function set instructions such as display type or interface size set
- Address set instructions
- Data read and write instructions
- Other instructions

The Busy Flag/Address Read instruction is the only instruction that can be executed while the LC7985 is executing a previous instruction. Before transmitting any other instruction, the microcontroller should either check that the busy flag is OFF or else wait longer than the execution time of the previous instruction.

Data read and write instructions are usually the most frequently used instructions. For increased microcontroller efficiency, a display shift and display data write can be executed simultaneously. In addition, the address counter automatically increments or decrements after either a data read or data write instruction, which reduces the operations required by the microcontroller. Note that the increment or decrement occurs after the busy flag turns OFF. The delay until the address counter updates is $t_{ADD} = 1.5/f_{CP}$ or $t_{ADD} = 1.5/f_{OSC}$, and is shown in the following figure.

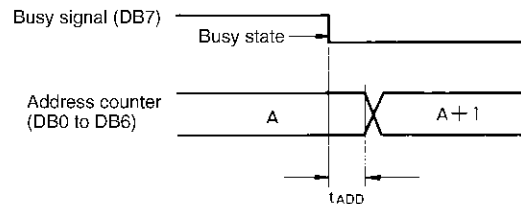

The instructions are shown in the following table. The instruction code comprises the RS, R/W and DB0 to DB7 signals.

Instruction	Code										Description	Execution time ^{*1} (max) (f_{CP} or $f_{OSC} = 250kHz$)
	RS	R/W	DB7	DB6	DB5	DB4	DB3	DB2	DB1	DB0		
Display Clear	0	0	0	0	0	0	0	0	0	1	Clears the display and sets the address counter to DD RAM address 0.	1.64ms
Cursor Home	0	0	0	0	0	0	0	0	1	×	Sets the address counter to DD RAM address 0. Returns a shifted display to the original position. Does not alter the DD RAM data	1.64ms
Set Entry Mode	0	0	0	0	0	0	0	1	I/D	S	Sets cursor movement and display shift following a data read or write. When I/D is 1, the cursor increments, and when 0, decrements. When S is 1, the display also shifts.	40μs
Display ON/OFF	0	0	0	0	0	0	1	D	C	B	When D is 1, the display is ON, and when 0, OFF. When C is 1, the cursor is ON, and when 0, OFF. When B is 1, blinking of the character at the cursor position is ON, and when 0, OFF.	40μs
Cursor/Display Shift	0	0	0	0	0	1	S/C	R/L	×	×	Moves the cursor or the display without altering the DD RAM data. When S/C is 1, the display shifts, and when 0, the cursor moves. When R/L is 1, the direction is right, and when 0, left.	40μs
Set Function	0	0	0	0	1	DL	N	F	×	×	When DL is 1, the interface size is eight bits, and when 0, four bits. When N is 1, the display size is two lines, and when 0, a single line. When F is 1, the font size is 5 × 10 pixels, and when 0, 5 × 7 pixels.	40μs
Set CGRAM Address	0	0	0	1	CGRAM address						Sets the CGRAM address. Data read and writes after this instruction are to and from CGRAM.	40μs
Set DD RAM Address	0	0	1	DD RAM address						Sets the DD RAM address. Data read and writes after this instruction are to and from DD RAM.	40μs	
Busy Flag/Address Read	0	1	BF	Address counter						Used during execution of other instructions, outputs the busy flag state and the address counter value. The address counter is used for both DD RAM and CGRAM.	0μs	
Data Write	1	0	Write data						Writes data to DD RAM or CGRAM.	40μs ($t_{ADD} = 6μs$)		
Data Read	1	1	Read data						Reads data from DD RAM or CGRAM.	40μs ($t_{ADD} = 6μs$)		
	I/D = 1: increment S = 1: accompanied by display shift S/C = 1: display shift R/L = 1: right shift DL = 1: 8-bit N = 1: two rows F = 1: 5 × 10-pixel characters BF = 1: internally operating I/D = 0: decrement S/C = 0: cursor shift R/L = 0: left shift DL = 0: 4-bit N = 0: a row F = 0: 5 × 7-pixel characters BF = 0: open to instructions										DD RAM : display data RAM CGRAM : character generator RAM A_{CG} : CGRAM address A_{DD} : DD RAM address, corresponding to cursor address AC : address counter used for both DD RAM and CGRAM	

Note: *1. The execution time depends on the operating frequency. For example, if f_{CP} or $f_{OSC} = 270kHz$, the execution time is $40μs \times 250/270 = 37μs$.

Display Clear

	RS	R/W	DB ₇						DB ₀
Code	0	0	0	0	0	0	0	0	0	1

Fills the DD RAM with space characters (20_H), returns the display to the unshifted position and sets the address counter to zero, returning the cursor to the top-left display position. The address counter increment/decrement mode is set to increment. The character blinking and display shift modes are not affected.

Note that if a custom character generator ROM is used, the space character must correspond to the 20_H character code for the display to be cleared correctly.

Cursor Home

	RS	R/W	DB ₇						DB ₀
Code	0	0	0	0	0	0	0	0	1	*

* Don't care

Returns the display to the unshifted position and sets the address counter to zero, returning the cursor to the top-left display position. Does not alter the DD RAM data.

Set Entry Mode

	RS	R/W	DB ₇						DB ₀
Code	0	0	0	0	0	0	0	1	I/D	S

Sets the cursor auto-increment direction and the display shift mode and direction. When I/D is 1, the address counter increments when data is read from or written to either the DD RAM or the CG RAM, thereby shifting the cursor right one character position. When I/D is 0, the address counter decrements, shifting the cursor left.

When S is 1, display shift is ON, and the display also shifts one character position to the right or left when data is written to the DD RAM so that the cursor position relative to the display is unchanged. No display shift occurs when data is read from the DD RAM or when data is read from or written to the CG RAM, although the address counter increments or decrements for all read and write operations. When S is 0, display shift is OFF.

Display ON/OFF

	RS	R/W	DB ₇						DB ₀
Code	0	0	0	0	0	0	1	D	C	B

Sets the display, the cursor and character blinking ON or OFF.

When D is 1, the display is ON, and when 0, OFF. Setting the display ON or OFF does not alter the address counter or the DD RAM data.

When C is 1, the cursor is ON, and when 0, OFF. Setting the cursor ON or OFF does not affect the cursor auto-increment and display shift modes.

When B is 1, the cursor and the character at the cursor position blink, alternating between black (all pixels ON) and the displayed character as shown in the following figure. When f_{CP} or $f_{OSC} = 250\text{kHz}$, the blink interval is 409.6ms, and when f_{CP} or $f_{OSC} = 270\text{kHz}$, 379.2ms.

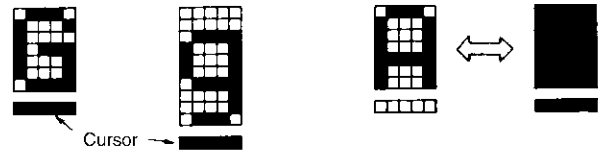

5 x 7-pixel character

5 x 10-pixel character

Alternating display

(a) Cursor display

(b) Character blinking display

Cursor/Display Shift

	RS	R/W	DB ₇						DB ₀
Code	0	0	0	0	0	1	S/C	R/L	*	*

* Don't care

Shifts the cursor or the display either left or right as shown in the following table. A DD RAM write is not required.

When shifting a 2-line display, both rows shift simultaneously, but characters do not move from one row to another. Each time the display shifts, the characters in each row only move within the row.

S/C	R/L	Description
0	0	Decrements the address counter and shifts the cursor left.
0	1	Increments the address counter and shifts the cursor right.
1	0	Shifts the display left. The address counter does not change, and the cursor moves with the display.
1	1	Shifts the display right. The address counter does not change, and the cursor moves with the display.

Microcontroller Interface

8-bit interface

DB0 to DB7 are used for the 8-bit data bus. The timing sequence for instruction write, instruction execution, and busy flag checking is shown in the following figure.

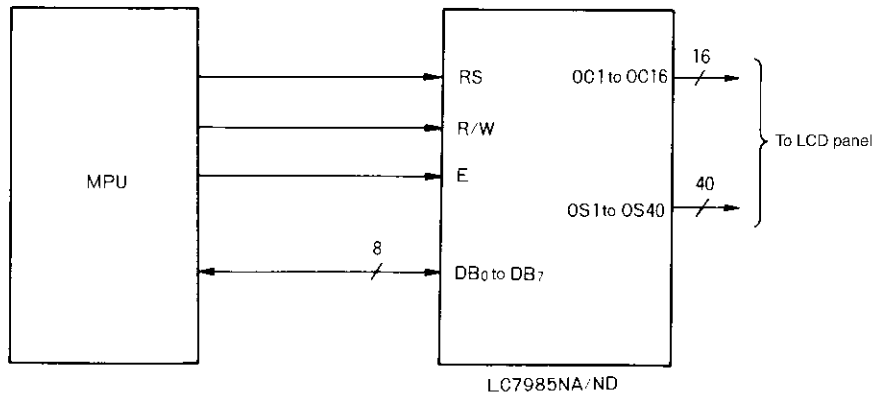
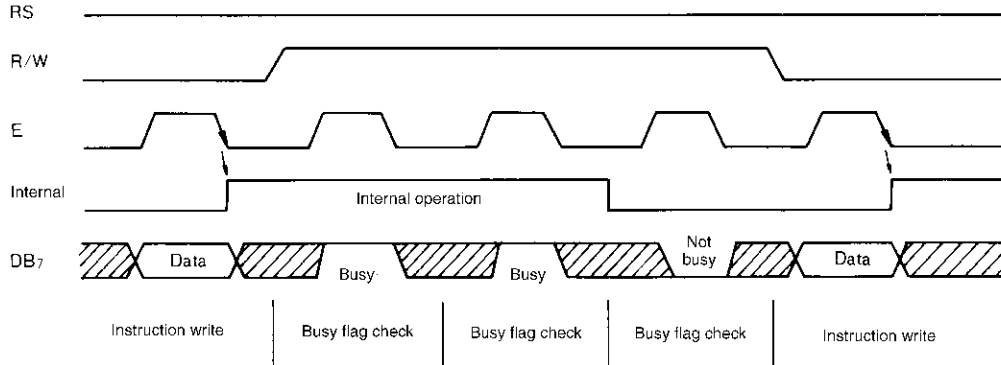

4-bit interface

The timing sequence for instruction write, instruction execution and busy flag checking is shown in the following figure. The busy flag is checked after transferring two 4-bit sets of data. The busy flag and address counter value are

output as two 4-bit words. Checking the busy flag, therefore, requires two read cycles so the low-order four bits of the address counter value are flushed from the data buffer.

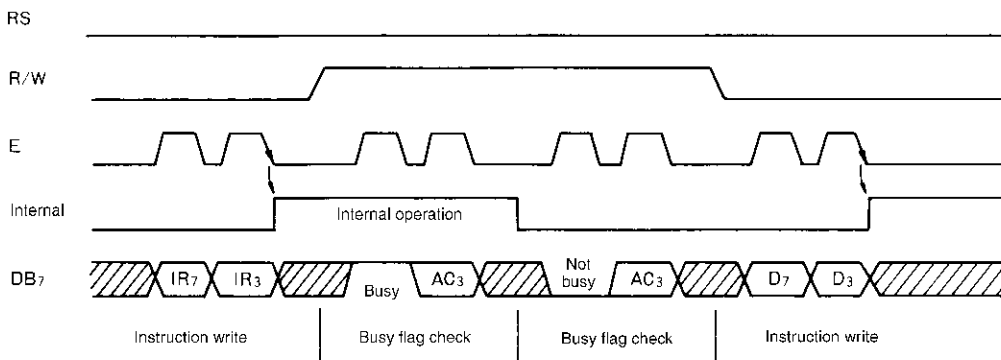

Note. IR7 and IR3 are the 7th and 3rd bit, respectively, of the instruction. AC3 is the 3rd bit of the address counter.

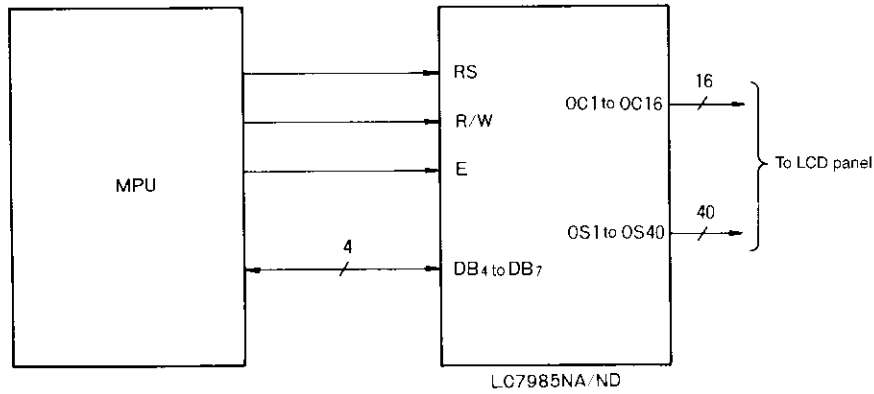

LCD Interface

The number of common signals and the duty cycle for each combination of font and display lines are shown in the following table. One common signal is required for each pixel-row in the character, and an additional common signal is required for the cursor row beneath the character.

Display lines	Font size	Common signals	Duty
1	5 × 7-pixel + cursor	8	1/8
1	5 × 10-pixel + cursor	11	1/11
2	5 × 7-pixel + cursor	16	1/16

Sample Application Circuits

1-line × 8-character, 1/4-bias and 1/8-duty Display with 5 × 7-pixel Font

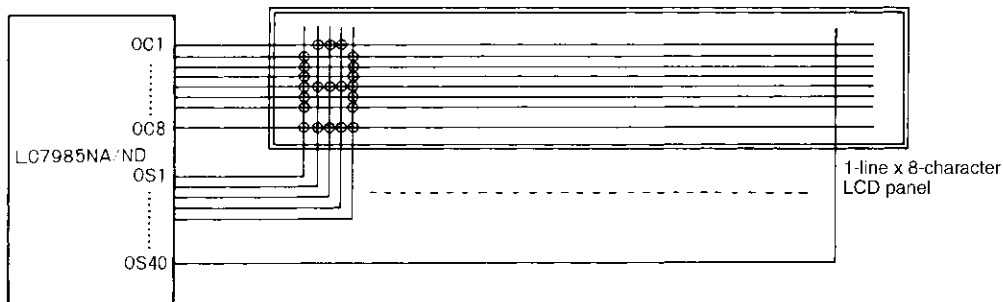

1-line × 8-character, 1/4-bias and 1/11-duty Display with 5 × 10-pixel Font

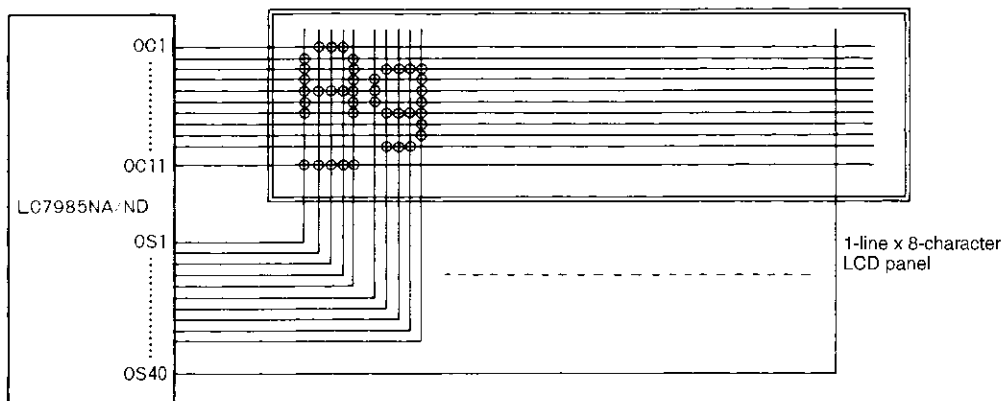

2-line × 8-character, 1/5-bias and 1/16-duty Display with 5 × 7-pixel Font

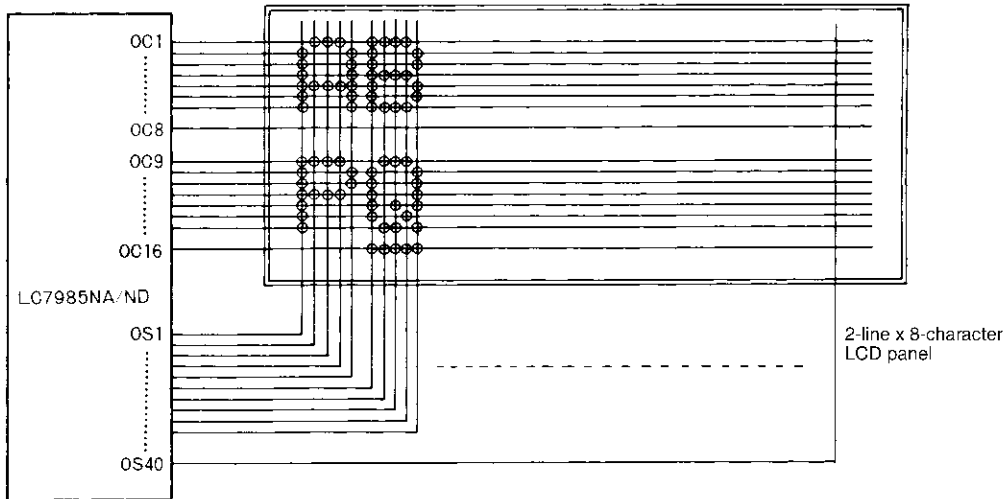

Connecting Unused Display Rows

Connecting unused LCD panel common pins to an unused LC7985 common output pin as shown in the following figure prevents crosstalk from the active drive signals affecting the display.

1-line × 8-character, 1/4-bias and 1/8-duty Display with 5 × 7 pixel Font

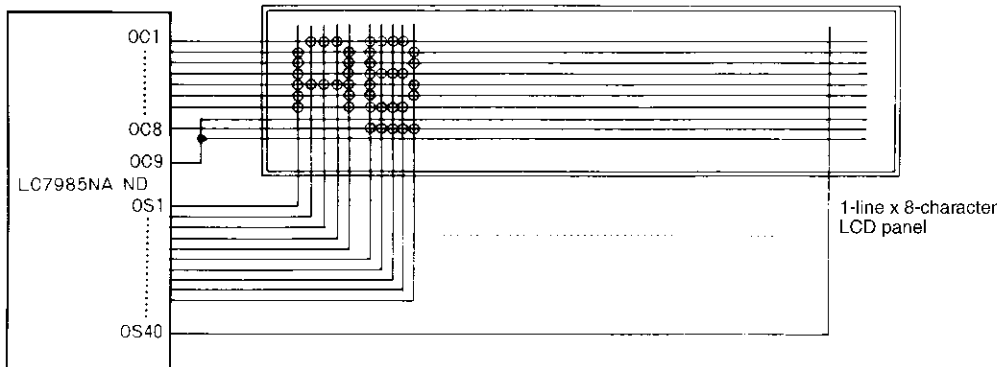

Alternative Display Connections

The LC7985 to LCD panel connections can be varied to match the LCD panel matrix as shown in the following sections.

1-line × 16-character, 1/8-bias and 1/16-duty Display with 5 × 7 pixel Font

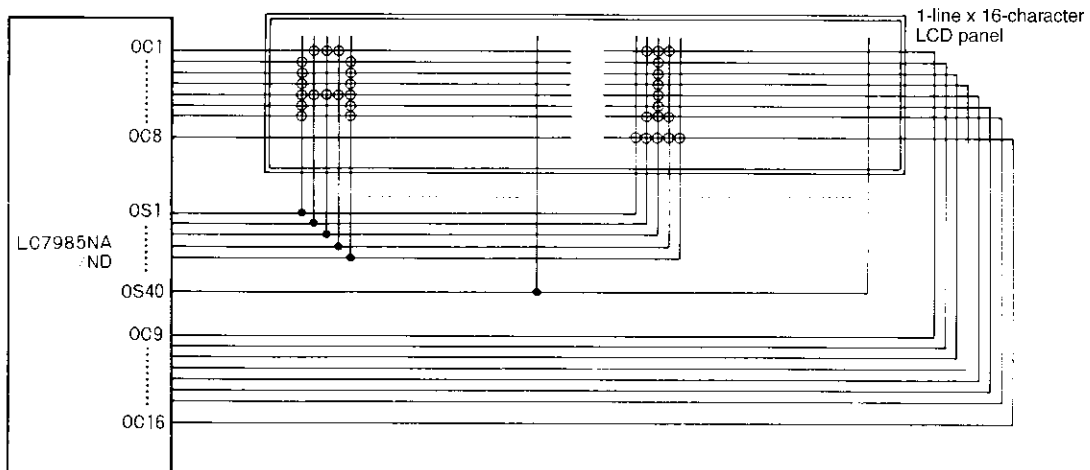

2-line × 4-character, 1/4-bias and 1/8-duty Display with 5 × 7 pixel Font

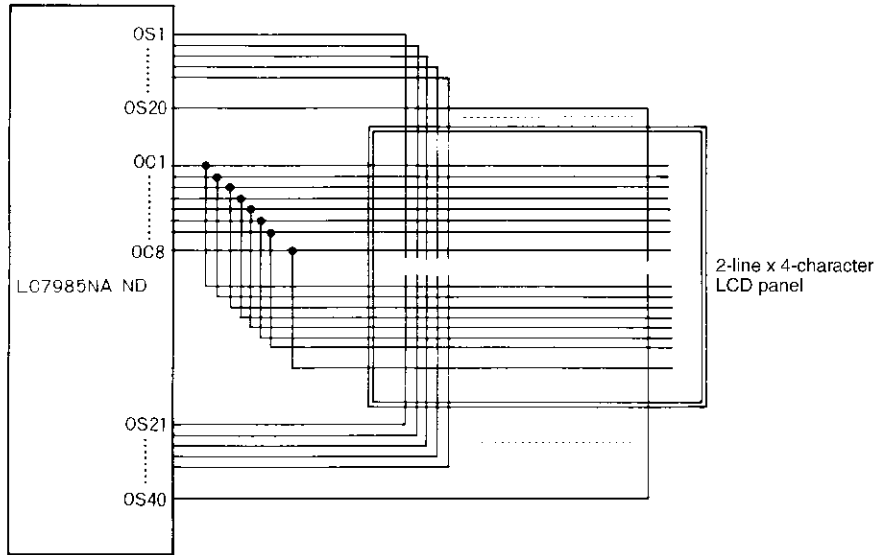

LCD driver power supply

The reference voltage levels required to generate the LCD drive waveforms are shown in the following table.

Voltages V_1 to V_5 are input on pins V_1 to V_5 , respectively. The voltages can be produced using a voltage-divider resistor network. The voltages required depend upon the duty cycle. V_{LCD} is the LCD driver peak voltage, where $V_{LCD} = V_{DD} - V_5$.

Voltage	1/4 bias and 1/8 or 1/11 duty	1/5 bias and 1/16 duty
V_1	$V_{DD} - 0.25V_{LCD}$	$V_{DD} - 0.2V_{LCD}$
V_2	$V_{DD} - 0.5V_{LCD}$	$V_{DD} - 0.4V_{LCD}$
V_3	$V_{DD} - 0.5V_{LCD}$	$V_{DD} - 0.6V_{LCD}$
V_4	$V_{DD} - 0.75V_{LCD}$	$V_{DD} - 0.8V_{LCD}$
V_5	$V_{DD} - V_{LCD}$	$V_{DD} - V_{LCD}$

1/8 duty LCD drive

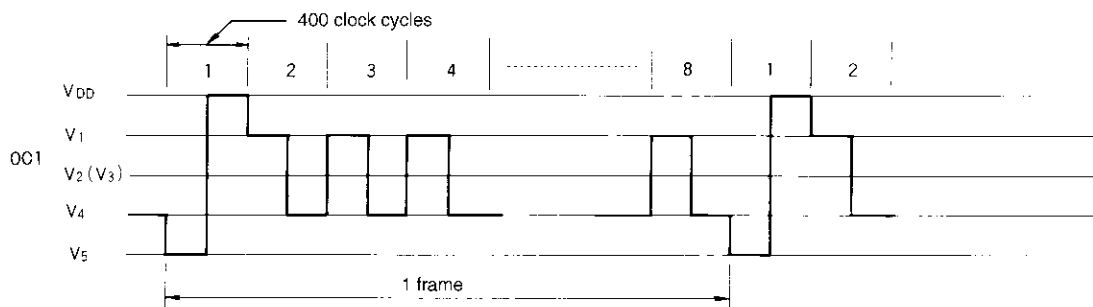

$$1 \text{ frame} = 4 \mu\text{s} \times 400 \times 8 = 12800 \mu\text{s} = 12.8 \text{ ms}$$

$$\text{Frame frequency} = \frac{1}{12.8} = 78.1 \text{ Hz}$$

1/11 duty LCD drive

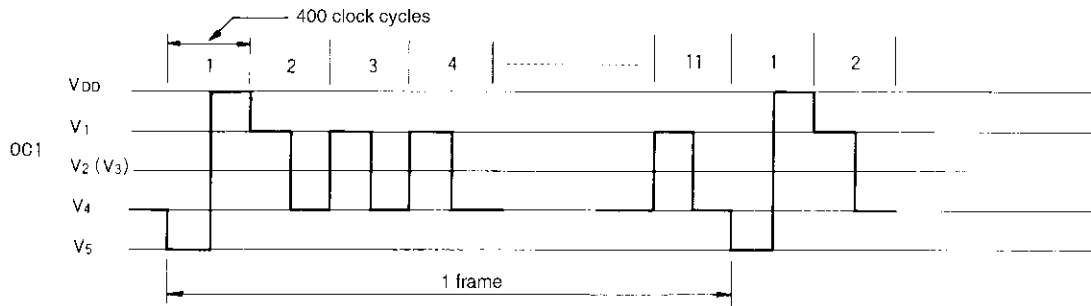

$$1 \text{ frame} = 4 \mu\text{s} \times 400 \times 11 = 17600 \mu\text{s} = 17.6 \text{ ms}$$

$$\text{Frame frequency} = \frac{1}{17.6 \text{ ms}} = 56.8 \text{ Hz}$$

1/16 duty LCD drive

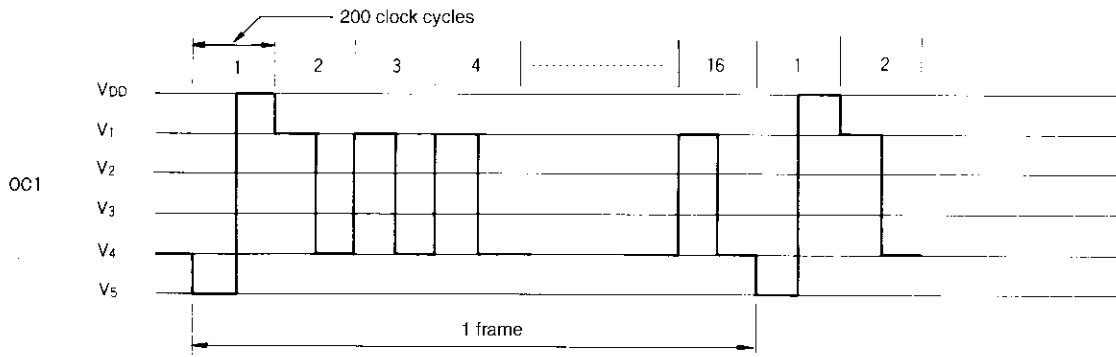

$$1 \text{ frame} = 4 \mu\text{s} \times 200 \times 16 = 12800 \mu\text{s} = 12.8 \text{ ms}$$

$$\text{Frame frequency} = \frac{1}{12.8 \text{ ms}} = 78.1 \text{ Hz}$$

LC7930N Interface

When using a single-line display, up to nine LC7930Ns, and when using a two-line display, up to four LC7930Ns can interface to the LC7985 using the circuit shown in the following figure. The LC7985 LOAD, CP, M and D outputs connect directly to the LC7930Ns. Take care that the V1 to V5 voltage reference outputs are connected correctly to the LC7930Ns.

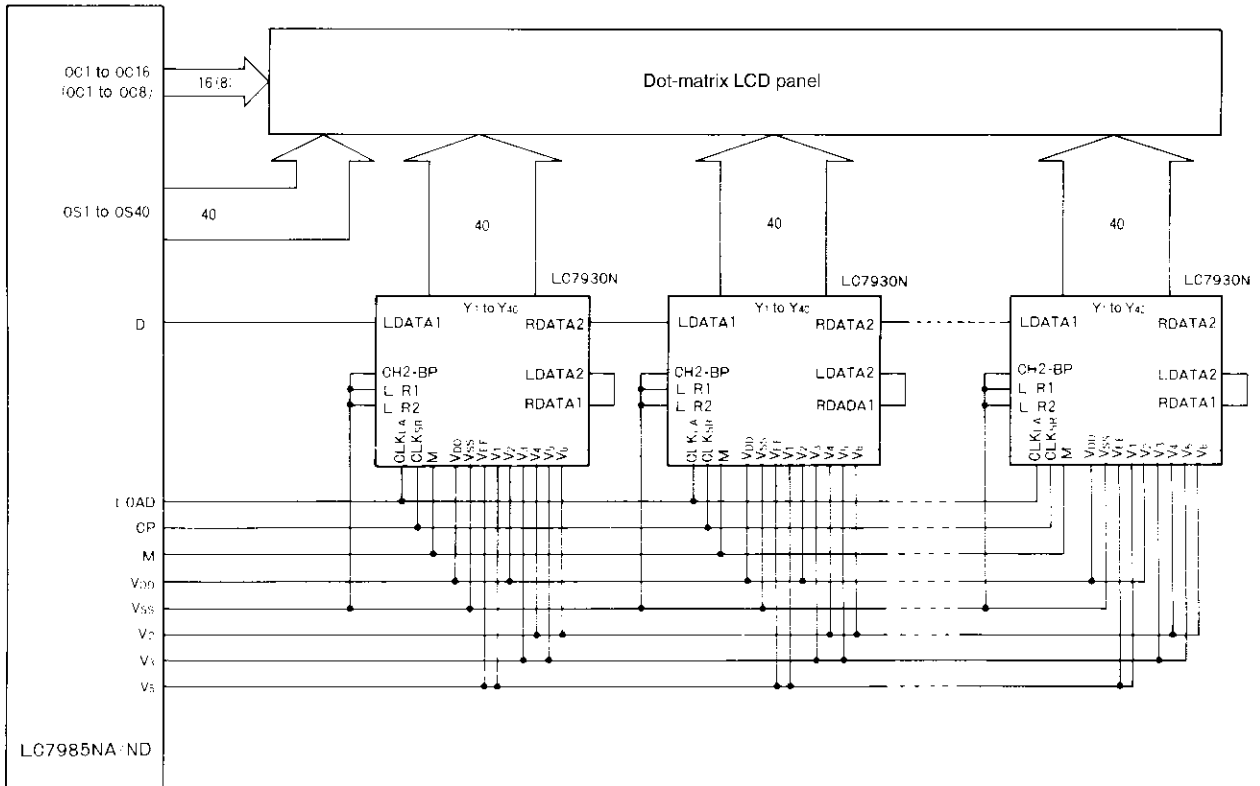

Examples

8-bit interface size, 1-line × 8-character display and internal reset circuit

The programming example is shown in the following table. This example assumes that the internal reset circuit initializes the LC7985.

The Set Function instruction that is executed before the display is turned ON determines the operation of the device.

Since the DD RAM stores 80 characters, the display shift function can be used as shown in the example. Note that display shifts only change the display position and do not alter the DD RAM. Using the Cursor Home instruction, therefore, returns the display to its original position.

Instruction	Code										Display	Description
	RS	R/W	DB7	DB6	DB5	DB4	DB3	DB2	DB1	DB0		
Power-ON												The internal reset circuit initializes the LC7985. The display is OFF.
Set Function	0	0	0	0	1	1	0	0	×	×		Sets 8-bit interface size, 1-line display size and 5 × 7-pixel character font. The number of display lines and the character font cannot be changed later.
Display ON/OFF	0	0	0	0	0	0	1	1	1	0		Turns the display ON and enables the cursor. The display is blank.
Set Entry Mode	0	0	0	0	0	0	0	1	1	0		Sets address auto-increment and automatic cursor right shift on writing to DD RAM or CG RAM. The display is not shifted.
Data Write	1	0	0	1	0	0	1	1	0	0		Writes 'L' to DD RAM, since DD RAM was selected when the LC7985 was initialized at power-ON. The cursor position increments and the cursor moves right.
Data Write	1	0	0	1	0	0	0	0	1	1		Writes 'C'.
Data Write	↓										↓	↓
Data Write	1	0	0	0	1	1	0	1	0	1		Writes '5'.
Set Entry Mode	0	0	0	0	0	0	0	1	1	1		Sets display shift on writing to DD RAM.
Data Write	1	0	0	0	1	0	0	0	0	0		Writes a space ' '.
Data Write	1	0	0	1	0	0	1	1	0	0		Writes 'L'.
Data Write	↓										↓	↓
Data Write	1	0	0	1	0	0	1	1	1	1		Writes 'O'.
Cursor/Display Shift	0	0	0	0	0	1	0	0	×	×		Shifts the cursor left.
Cursor/Display Shift	0	0	0	0	0	1	0	0	×	×		Shifts the cursor left.
Data Write	1	0	0	1	0	0	0	0	1	1		Writes 'C', the correct character. The display scrolls left.
Cursor/Display Shift	0	0	0	0	0	1	1	1	×	×		Shifts both the display and the cursor right.
Cursor/Display Shift	0	0	0	0	0	1	0	1	×	×		Shifts the cursor right.
Data Write	1	0	0	1	0	0	1	1	1	0		Writes 'N'.
Data Write	↓										↓	↓
Cursor Home	0	0	0	0	0	0	0	0	1	0		Sets both the display and the cursor position to 0.

8-bit interface size, 1-line × 8-character display and microcontroller initialization

The initialization sequence for an LC7985 using an 8-bit interface is shown in the following figure.

device, the LC7985 must be initialized using commands from the microcontroller.

Note that if power supply conditions are such that the internal reset circuit does not operate to initialize the

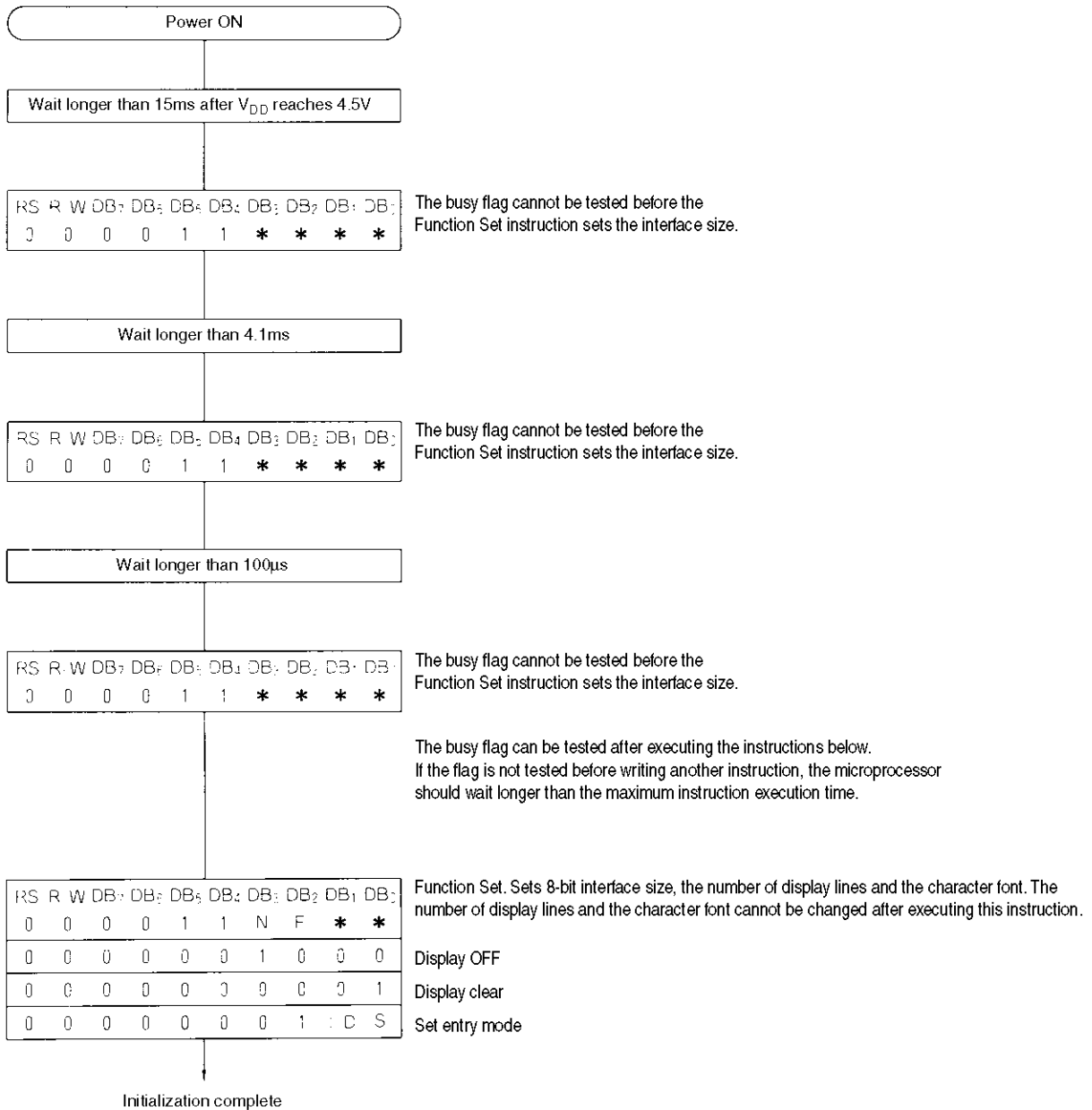

LC7985NA, LC7985ND

8-bit interface size, 2-line × 8-character display and internal reset circuit

The programming example is shown in the following table.

Note that each row uses 40 bytes of DD RAM. When the display is eight characters long, to move the cursor from the first row to the second, the DD RAM address should be reset after the eighth character as shown in the example.

When shifting the display, both rows shift simultaneously but characters do not move from one row to another. Each

time the display shifts, the characters in each row only move within the row.

Note that if power supply conditions are such that the internal reset circuit does not operate to initialize the device, the LC7985 must be initialized using commands from the microcontroller.

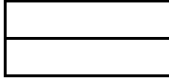
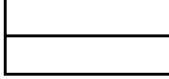
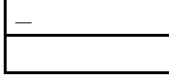
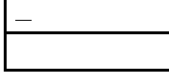
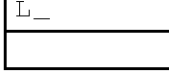
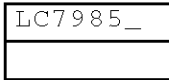
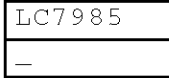
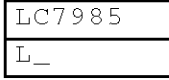
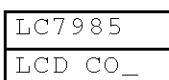
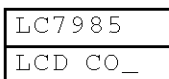
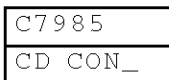
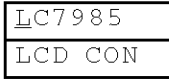
Instruction	Code										Display	Description
	RS	R/W	DB7	DB6	DB5	DB4	DB3	DB2	DB1	DB0		
Power-ON												The internal reset circuit initializes the LC7985. The display is OFF.
Set Function	0	0	0	0	1	1	1	0	×	×		Sets 8-bit interface size, 2-line display size and 5 × 7-pixel character font.
Display ON/OFF	0	0	0	0	0	0	1	1	1	0		Turns the display ON and enables the cursor. The display is blank.
Set Entry Mode	0	0	0	0	0	0	0	1	1	0		Sets address auto-increment and automatic cursor right shift on writing to DD RAM or CG RAM. The display is not shifted.
Data Write	1	0	0	1	0	0	1	1	0	0		Writes 'L' to DD RAM, since DD RAM was selected when the LC7985 was initialized at power-ON. The cursor position increments and the cursor moves right.
Data Write	↓										↓	↓
Data Write	1	0	0	0	1	1	0	1	0	1		Writes '5'.
Set DD RAM Address	0	0	1	1	0	0	0	0	0	0		Sets the DD RAM address to the first position in the second row.
Data Write	1	0	0	1	0	0	1	1	0	0		Writes 'L'.
Data Write	↓										↓	↓
Data Write	1	0	0	1	0	0	1	1	1	1		Writes 'O'.
Set Entry Mode	0	0	0	0	0	0	0	1	1	1		Sets display shift on writing to DD RAM.
Data Write	1	0	0	1	0	0	1	1	1	0		Writes 'N'. The display scrolls left. The two lines scroll simultaneously.
Data Write	↓										↓	↓
Cursor Home	0	0	0	0	0	0	0	0	1	0		Sets both the display and the cursor position to 0.

4-bit interface size, 1-line × 8-character display and microcontroller initialization

The initialization sequence for an LC7985 using a 4-bit interface is shown in the following figure.

The Function Set instruction is required to set the interface size. With a 4-bit interface size, two write accesses are required for each instruction. Since 8-bit interface size is selected when the LC7985 is initialized at power-ON, the first write access is to an 8-bit interface on the LC7985.

DB0 to DB3 are not connected, however, and are not written. The Function Set instruction should therefore be repeated, writing DB4 to DB7 again and then DB0 to DB3, to initialize the device.

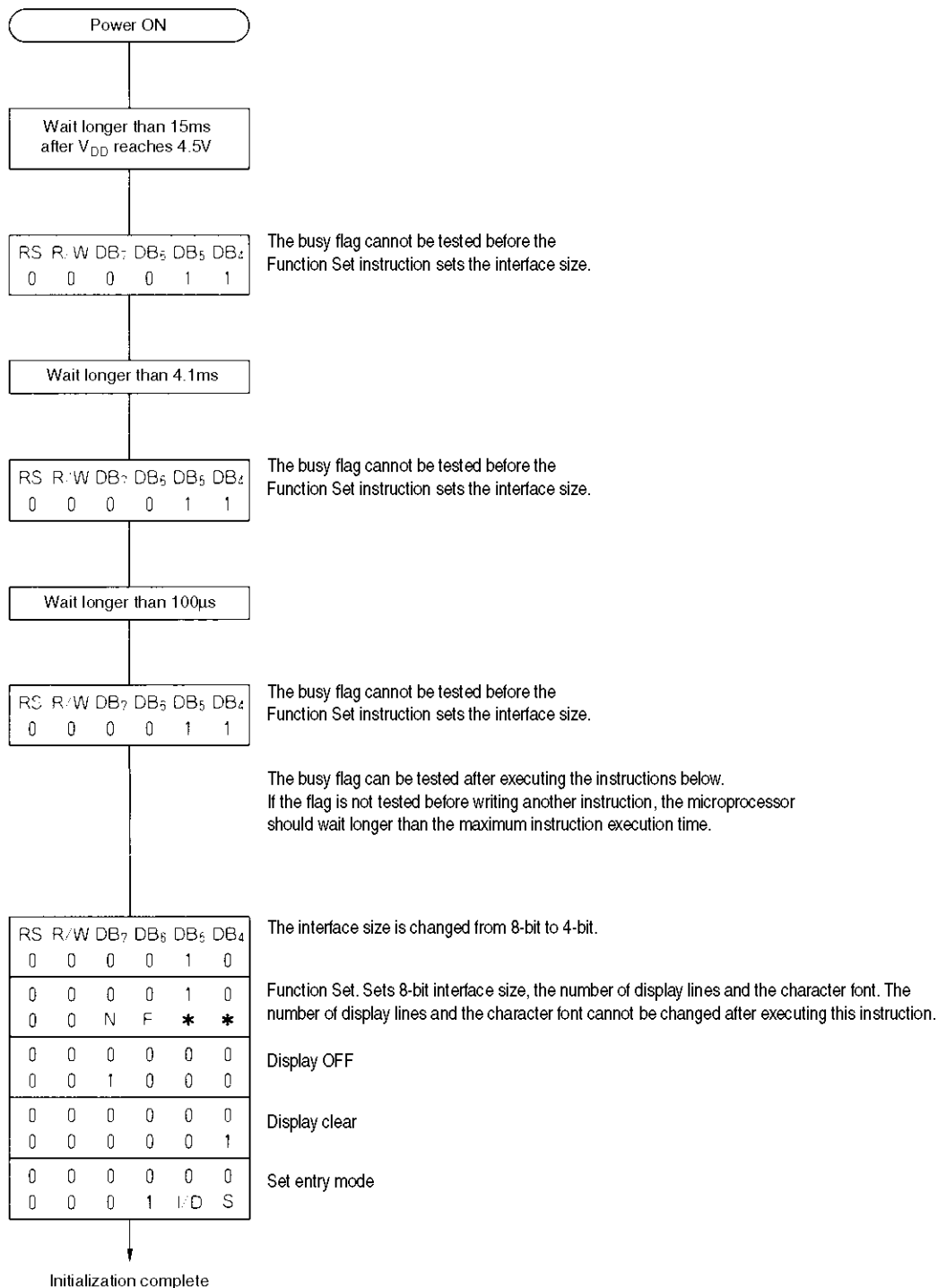

- No products described or contained herein are intended for use in surgical implants, life-support systems, aerospace equipment, nuclear power control systems, vehicles, disaster/crime-prevention equipment and the like, the failure of which may directly or indirectly cause injury, death or property loss.
- Anyone purchasing any products described or contained herein for an above-mentioned use shall:
 - ① Accept full responsibility and indemnify and defend SANYO ELECTRIC CO., LTD., its affiliates, subsidiaries and distributors and all their officers and employees, jointly and severally, against any and all claims and litigation and all damages, cost and expenses associated with such use:
 - ② Not impose any responsibility for any fault or negligence which may be cited in any such claim or litigation on SANYO ELECTRIC CO., LTD., its affiliates, subsidiaries and distributors or any of their officers and employees, jointly or severally.
- Information (including circuit diagrams and circuit parameters) herein is for example only; it is not guaranteed for volume production. SANYO believes information herein is accurate and reliable, but no guarantees are made or implied regarding its use or any infringements of intellectual property rights or other rights of third parties.

This catalog provides information as of July, 1997. Specifications and information herein are subject to change without notice.